

S.22 Through Fix Door Spare Kit—CM KIT 009

S221 -v3

If in doubt, Seaglaze would always recommend the use of an experienced fitting team. If you do not know any then we would be happy to point you towards some of our relevant customers who fit our products on a regular basis.



What's Included:

- 3x S.53 CWH Hinge Assembly (CM HIN 680) -Anodised Silver Satin
- 6m 15mm x 10mm Foam Seal—Self Adhesive (SE SEA 020)
- 1x Duralac (CO LUB 023)
- 6mm Bubble Seal (SE SEA 309)
- 3x G40 Door Wedge (FT WDG 601)
- 6m Internal Screw Cover (SE COV 102)
- 6m Brush Pile 8mm (SE SLD 005)
- 6x Shims 2mm ((FT WDG 707)
- 1 Scotchweld Instant Adhesive (CO ADH 050)

How to Use:

- Hinge Assembly—Used to replace broken or damaged Hinge. See M371—Replacing a S.53 CWH Hinge
- Seal—Used to replace broken or damaged Seal. See M380—Replacing a Seal
- Duralac—Used to coat all screws before fixing, this helps prevent corrosion.
- Screw Cover—Used to replace broken or damaged Screw Cover.
- Bubble Seal—Used to replace damaged or worm bubble seal.
- Brush Pile—Used to replace damaged or worn brush pile.
- Door Wedge—Used to replace damaged door wedges to ensure the door pulls in tight when closed.
- Scotchweld Instant Adhesive—used to fix in bubble seal in track

Where Things go:

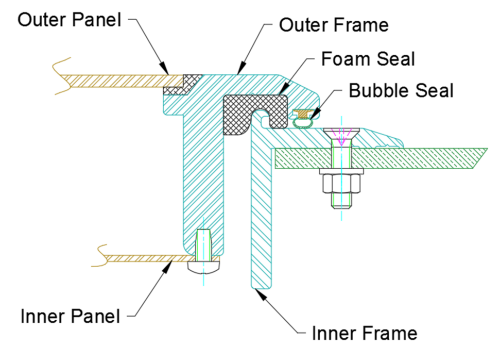

S.22 Through Fix Door Spare Kit—CM KIT 009

S221 -v2

Required Equipment:

- Screw Driver
- * Cleaning Materials

Other useful instructions include...

- M220—S.22 Door Maintenance
- Z010—Recommended products for maintenance

Find our other instructions at www.seaglaze.co.uk