

S.24 Door Kit—CM KIT 006

S240 -V3

If in doubt, Seaglaze would always recommend the use of an experienced fitting team. If you do not know any then we would be happy to point you towards some of our relevant customers who fit our products on a regular basis.



What's Included:

- 6m S.24 Door Seal (SE SEA 200 A)
- 1x Duralac (CO LUB 023)
- 10x Shims 2mm (FT WDG 707)
- 3x G40 Door Wedge (FT WDG 806)
- 1 Scotchweld Instant Adhesive (CO ADH 050)
- 1x 8mm Hex Key (TL HEX 080)
- 12x Machine Screws, Csk, Pozi, M6 x 14 (FA BCP 414)
- 12x Machine Screws, Csk, Pozi, M6 x 16 (FA BCP 416)

How to Use:

- S.24 Door Seal—Used to replace broken or damaged Seal. See M380—Replacing a Seal
- Duralac—Used to coat all screws before fixing, this helps prevent corrosion.
- Shims 2mm—Spacers to adjust height of wedges/ Closing force of dogs.
- G40 Door Wedge—Used to replace damaged door wedges to ensure the door pulls in tight when closed.
- Scotchweld Instant Adhesive—used to fix in seal
- 8mm Hex Key—Used to remove dogs.
- Machine Screws, Csk, Pozi, M6 x 14—To hold door wedges in place.
- Machine Screws, Csk, Pozi, M6 x 16—To hold door wedges in place.

Other useful instructions include...

- M240—S.24 Door Maintenance
- Z010—Recommended products for maintenance

Where Things go:

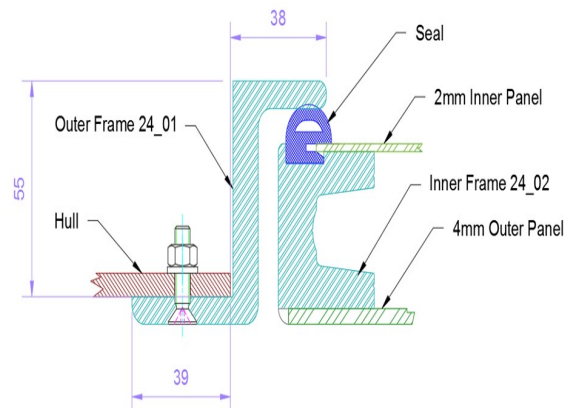

Required Equipment:

- Screw Driver
- Cleaning Materials

Find our other instructions at www.seaglaze.co.uk