



## Catches

Part	Description	Status	Reference	Page
<b>KS-48</b>	<b>Flush Catch</b>			<b>2</b>
FT CAT 102	M/S Novibra Flush Catch	Active	48-1	2
FT CAT 103	Flush Catch	Active	48-2	2
FT CAT 106	Push to close latch 7-12mm Panel Black Locking	Active	48-3	2
FT CAT 113	Push to close latch 17-22mm Panel White Locking	Active	48-4	2
<b>KS-49</b>	<b>Mounts/Spacers</b>			<b>3</b>
FT CAT 062	Backing Plate for CAT 060 8mm Nylon	Active	49-1	3
FT CAT 125	G40 Shoot Bolt Barrel	Manufactured Internally		3
FT CAT 127	Acrylic catch plate, for S.29 Shower doors	Active	49-3	3
FT CAT 128	Acrylic "Ring" spacer, for catch on S.29 Shower d	Active	49-4	3
<b>KS-51</b>	<b>Tri-Catches</b>			<b>4</b>
FT CAT 011	Tri Catch Base, 50mm, Mill	Active	51-1	4
FT CAT 012	Tri Catch Lever, 50mm, Mill	Active	51-2	4
FT CAT 013	Tri Catch Spring	Active	51-3	4
FT CAT 015	Tri Catch Keep, 50mm, Mill	Active	51-4	4
FT CAT 011 Y	Tri Catch Base, 75mm, Mill	Active	51-5	5
FT CAT 012 Y	Tri Catch Lever, 75mm, Mill	Active	51-6	5
FT CAT 015 Y	Tri Catch Keep, 75mm, Mill	Active	51-7	5
<b>KS-52</b>	<b>Toggle Catches</b>			<b>6</b>
FT CAT 080	Turnbutton - S.03 Port/Hopper	Active	52-1	6
FT CAT 160	Flick Over	Active	52-2	6
FT CAT 170	Toggle Fastener	Active	52-3	6
FT CAT 210 A	Wroxham Bottom Rail Hold Back - catch	Buy as Needed	52-4	6
FT CAT 400	75mm Chrome Plated Barrel Bolt	Active	52-5	7
FT CAT 401	75mm Chrome Plated Barrel Bolt	Active	52-6	7
FT CAT 500	Integral shoot bolt for Sliding doors	Active	52-7	7
<b>KS-47</b>	<b>Cam Lever</b>			<b>8</b>
FT CAT 060 H	Camlever, Left.Schlegel 6036	Active	47-1	8
FT CAT 070 H	Turnbutton A816, Left	Active	47-2	8

Explanation: These are fitted into a prepared hole so the catch itself sits flush with the door, hence the name.

<p>Status: Active Material: Plastic Colour: Black</p> <p>Height: Unknown Width: Unknown Weight: 44 g</p> <p>Prime Series: Diameter 45mm Overall Length 55mm</p>	<p><b>48-1</b> Normal <b>FT CAT 102</b></p>  <p>M/S Novibra Flush Catch</p>
---	--

<p>Status: Active Material: Plastic Colour: Black</p> <p>Height: Unknown Width: Unknown Weight: 41 g</p> <p>Prime Series: Diameter 37mm Overall length 52mm</p>	<p><b>48-2</b> Normal <b>FT CAT 103</b></p>  <p>Flush Catch</p>
---	--

<p>Status: Active Material: Plastic Colour: Black</p> <p>Height: 38 mm Width: Unknown Weight: 38 g</p> <p>Prime Series: Diameter 62mm Number of Keys 2</p>	<p><b>48-3</b> Normal <b>FT CAT 106</b></p>  <p>Push to close latch 7-12mm Panel Black Locking</p>
--	--

<p>Status: Active Material: Plastic Colour: White</p> <p>Height: 38 mm Width: Unknown Weight: 62 g</p> <p>Prime Series: Diameter 62mm Number of Keys 2</p>	<p><b>48-4</b> Normal <b>FT CAT 113</b></p>  <p>Push to close latch 17-22mm Panel White Locking</p>
--	---

Explanation: Mount - fitted to a Series 24 and 28 Seaglaze Door. Chamber for the locking mechanism.

<p>Status: Active Material: Nylon Colour: Black</p> <p>Height: 77 mm Width: 23 mm Weight: 16 g</p> <p>Prime Series: Mounting Pitch 58mm</p>	<p><b>49-1</b> Normal <b>FT CAT 062</b></p>  <p><b>Backing Plate for CAT 060 8mm Nylon</b></p>
---	--

<p>Status: Manufactured Internally Material: Aluminium Colour: Mill Finish</p> <p>Height: 100 mm Width: 25 mm Weight: 72 g</p> <p>Prime Series: 24 Overall length 100mm Overall Width 25mm Overall Height</p>	<p><b>49-2</b> Normal <b>FT CAT 125</b></p>  <p><b>G40 Shoot Bolt Barrel</b></p>
---	---

<p>Status: Active Material: Acrylic Colour: Transparent</p> <p>Height: Unknown Width: Unknown Weight: 9 g</p> <p>Prime Series: 29 Thickness 8mm Overall length 50mm Overall Width 19mm</p>	<p><b>49-3</b> Normal <b>FT CAT 127</b></p>  <p><b>Acrylic catch plate, for S.29 Shower doors</b></p>
--	---

<p>Status: Active Material: Acrylic Colour: Transparent</p> <p>Height: Unknown Width: Unknown Weight: 6 g</p> <p>Prime Series: 29 Diameter inner 49.5mm Diameter outer 57.5mm Thickness 6mm</p>	<p><b>49-4</b> Normal <b>FT CAT 128</b></p>  <p><b>Acrylic "Ring" spacer, for catch on S.29 Shower d</b></p>
---	--

Explanation: The name of this component comes from the three parts it is made up of. They are fitted to Seaglaze Sliding Windows. They are essentially the handle to open them.

<p>Status: Active      Height: 50 mm Material: Aluminium      Width: 50 mm Colour: Mill Finish      Weight: 40 g</p> <p>Prime Series: 10</p> <p>Mill finish shown, Anodised and Powder Coated finishes also available</p>	<p><b>51-1</b>      Normal      <b>FT CAT 011</b></p>  <p><b>Tri Catch Base, 50mm, Mill</b></p>
---	---

<p>Status: Active      Height: 50 mm Material: Aluminium      Width: 50 mm Colour: Mill Finish      Weight: 32 g</p> <p>Prime Series: 10</p> <p>Mill finish shown, Anodised and Powder Coated finishes also available</p>	<p><b>51-2</b>      Normal      <b>FT CAT 012</b></p>  <p><b>Tri Catch Lever, 50mm, Mill</b></p>
---	---

<p>Status: Active      Height: 20 mm Material: Stainless Steel      Width: 46 mm Colour: Mill Finish      Weight: 1 g</p> <p>Prime Series: 10</p>	<p><b>51-3</b>      Normal      <b>FT CAT 013</b></p>  <p><b>Tri Catch Spring</b></p>
---	---

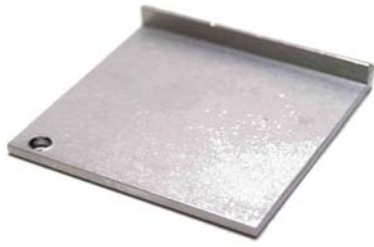
<p>Status: Active      Height: 51 mm Material: Aluminium      Width: 51 mm Colour: Mill Finish      Weight: 23 g</p> <p>Prime Series: 10</p> <p>Mill finish shown, Anodised and Powder Coated finishes also available</p>	<p><b>51-4</b>      Normal      <b>FT CAT 015</b></p>  <p><b>Tri Catch Keep, 50mm, Mill</b></p>
---	---

Explanation: The name of this component comes from the three parts it is made up of. They are fitted to Seaglaze Sliding Windows. They are essentially the handle to open them.

<p>Status: Active      Height: Unknown Material: Aluminium      Width: Unknown Colour: Grey      Weight: 63 g</p> <p>Prime Series: 10 Overall length 75mm Overall Width 50mm</p> <p>Pow der Coated finish show n, Anodised and Mill Finish also available</p>	<p><b>51-5</b>      Normal</p>  <p><b>FT CAT 011 Y</b></p> <p><b>Tri Catch Base, 75mm, Mill</b></p>
---	---

<p>Status: Active      Height: Unknown Material: Aluminium      Width: Unknown Colour: Grey      Weight: 51 g</p> <p>Prime Series: 10 Overall length 75mm Overall Width 50mm</p> <p>Pow der Coated finish show n, Anodised and Mill Finish also available</p>	<p><b>51-6</b>      Normal</p>  <p><b>FT CAT 012 Y</b></p> <p><b>Tri Catch Lever, 75mm, Mill</b></p>
---	---

<p>Status: Active      Height: 75 mm Material: Aluminium      Width: 50 mm Colour: Grey      Weight: 35 g</p> <p>Prime Series: 10</p> <p>Pow der Coated finish show n, Anodised and Mill Finish also available</p>	<p><b>51-7</b>      Normal</p>  <p><b>FT CAT 015 Y</b></p> <p><b>Tri Catch Keep, 75mm, Mill</b></p>
--	---

Explanation: This covers things such as shoot bolts. Basically they are catches that require some operation.

<p>Status: Active      Height: 50 mm Material: Aluminium      Width: 16 mm Colour: Anodised      Weight: 21 g  Prime Series: 03 Thickness 10mm</p>	<p><b>52-1</b>      Normal      <b>FT CAT 080</b></p>  <p><b>Turnbutton - S.03 Port/Hopper</b></p>
--	--

<p>Status: Active      Height: 25 mm Material: Brass      Width: Unknown Colour: Chrome      Weight: 15 g  Prime Series: Mounting Pitch 14mm</p>	<p><b>52-2</b>      Normal      <b>FT CAT 160</b></p>  <p><b>Flick Over</b></p>
--	--

<p>Status: Active      Height: Unknown Material: Stainless Steel      Width: Unknown Colour: Chrome      Weight: 58 g  Prime Series: Overall length 88mm Overall Width 33mm</p>	<p><b>52-3</b>      Normal      <b>FT CAT 170</b></p>  <p><b>Toggle Fastener</b></p>
---	--

<p>Status: Buy as Needed      Height: Unknown Material: Aluminium      Width: Unknown Colour: Anodised      Weight: 31 g  Prime Series: 23</p>	<p><b>52-4</b>      Normal      <b>FT CAT 210 A</b></p>  <p><b>Wroxham Bottom Rail Hold Back - catch</b></p>
--	---

Explanation: This covers things such as shoot bolts. Basically they are catches that require some operation.

<p>Status: Active      Height: Unknown Material: Brass      Width: Unknown Colour: Chrome      Weight: 76 g</p> <p>Prime Series: Overall length    75mm Overall Width    25mm</p>	<p><b>52-5</b>      Normal      <b>FT CAT 400</b></p>  <p><b>75mm Chrome Plated Barrel Bolt</b></p>
---	---

<p>Status: Active      Height: Unknown Material: Brass      Width: Unknown Colour: Chrome      Weight: 80 g</p> <p>Prime Series: Overall length    75mm Overall Width    25mm</p>	<p><b>52-6</b>      Normal      <b>FT CAT 401</b></p>  <p><b>75mm Chrome Plated Barrel Bolt</b></p>
---	--

<p>Status: Active      Height: Unknown Material: Aluminium      Width: Unknown Colour: Mill Finish      Weight: 112 g</p> <p>Prime Series: Overall length    171mm Overall Width    20mm Mounting Pitch    155mm</p>	<p><b>52-7</b>      Normal      <b>FT CAT 500</b></p>  <p><b>Integral shoot bolt for Sliding doors</b></p>
--	--

Explanation: These are catches fitted onto cabinets etc. The catch itself holds the door shut.

<p>Status: Active      Height: Unknown Material: Aluminium      Width: Unknown Colour: Anodised      Weight: 57 g</p> <p>Prime Series: 03 Mounting Pitch 56mm</p> <p>Left Hand shown, Right Hand also available</p>	<p><b>47-1</b>      Normal      <b>FT CAT 060 H</b></p>  <p><b>Camlever, Left.Schlegel 6036</b></p>
---	---

<p>Status: Active      Height: 85.5 mm Material: Brass      Width: 53 mm Colour: Grey      Weight: 93 g</p> <p>Prime Series: 51 Mounting Pitch 38mm</p> <p>Left Hand shown, Right Hand also available</p>	<p><b>47-2</b>      Normal      <b>FT CAT 070 H</b></p>  <p><b>Turnbutton A816, Left</b></p>
---	---